

Specification

规格书

Customer Name:

客户名称: _____

Customer P/N:

客户品号: _____

WeiZhi P/N:

纬智品号: WZ-2835-6V150mA

Sending Date:

送样日期: _____

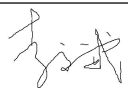
Customer approval 客户审核			WeiZhi approval 纬智光电审核		
Approval 核准	Audit 确认	Confirmation 制作	Approval 核准	Audit 确认	Confirmation 制作
					
<input type="checkbox"/> Qualified 接受		<input type="checkbox"/> Disqualified 不接受	DATE: 日期:		

版本 (Version): 1.0

您的宝贵意见是我们进步的源泉! Your advices are our source of progres!

COMMODITY: SURFACE MOUNT LED



ATTENTION
OBSERVE PRECAUTIONS
FOR HANDLING
ELECTROSTATIC
DISCHARGE
SENSITIVE
DEVICES

Description (描述)

3.50mm×2.80mmSMT-LED(表面贴片器件尺寸为3.50mm×2.80mm)

Colloid Color: Yellow/Orange (胶体颜色为黄色或橙色)

Features(特征)

Extremely wide viewing angle(宽的发光角度)

Suitable for all SMT assembly and solder process. (适用于的所有的SMT装配和焊接工艺)

HBM ESD:Class 2 (人体抗静电指标: Class 2)

RoHS compliant (符合 RoHS标准)

Applications(用途)

- Mobile phone flash(手机闪光灯)
- Architectural lighting(建筑照明)
- Interior automotive lighting(汽车应用)
- LCD TV / Monitor backlight(液晶电视/显示器背光源)
- Advertisement(广告应用)

Package Dimensions(封装尺寸)

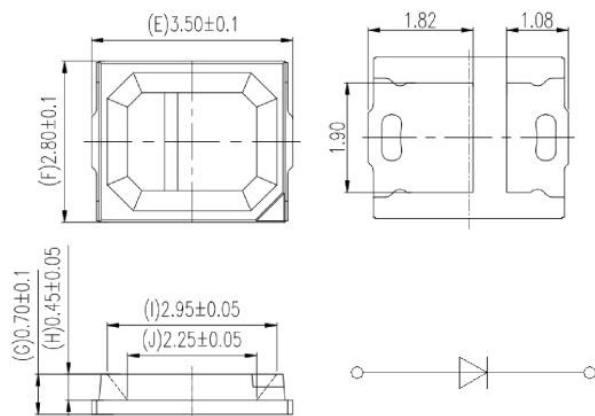

Recommended Soldering PATTERN (建议焊盘尺寸)

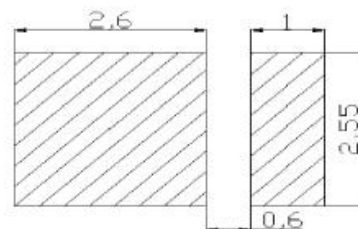

Notes:

1. All dimension units are millimeters. (所有标注尺寸的单位均为毫米)
2. All dimension tolerance is ±0.2mm unless otherwise noted. (除特别说明,所有尺寸的公差均为±0.2mm)

Adr: No.175,anshan road,Chengdong-East industrial zone,yuyao city,zhejiang province

地址: 浙江省余姚城东工业区安山路 175 号

Tel/电话: 0574-62530115 Fax/传真: 0574-62531066 Web: www.weizhi-led.com

Absolute Maximum Ratings (极限参数) (Ta=25°C)

Item (参数)	Symbol (符号)	Value (值)	Unit (单位)
Power Dissipation (功耗)	PD	1100	mW
DC Forward Current (正向电流)	IF	150	mA
Pulsed Forward Current (正向峰值电流)	IFP	250 ^{*1}	mA
Reverse Voltage (反向电压)	VR	15	V
Operating Temperature (工作温度范围)	Topr	-30~ +85	°C
Storage Temperature (储存温度范围)	Tstg	-40 ~ +100	°C
Soldering Temperature (焊接温度)	Tsol	260/10sec	°C
Junction Temperature (结温)	Tj	100	°C
Junction/Solder point (热阻/焊点)	Rthjs	18	°C/W

*1 Duty 1/10, Pulse Width 0.1ms. (占空比1/10, 脉冲宽度0.1ms)

Electrical-Optical Characteristics^{*1} (光电参数) (Ta=25°C)

Parameter 参数	Test Condition 测试条件	Symbol 符号	Min 最小值	Typ 典型值	Max 最大值	Unit 单位
Forward Voltage 正向电压	IF=150mA	VF	---	6.2	---	V
Reverse Current 反向电流	VR=-10V	IR	---	---	5	μA
View Angle 发光角度	IF=150mA	2θ 1/2	---	120	---	deg.
Luminous flux 光通量	IF=150mA	ΦV	105	---	130	lm
Color Coordinates 色度坐标	IF=150mA	X	---	---	---	
		Y	---	---	---	
Color Temperature 色温	IF=150mA	CCT	2600	---	6800	K
Color Rendering index 显指	IF=150mA	Ra	80	---	---	---
Color tolerance 色容差	IF=150mA	SDCM	---	---	6	---

Note: the test tolerance (测试公差)

VF : ±0.05V CCT : ±5% XY : ±0.005 ΦV : ±10% Ra : ±2

Adr: No.175, anshan road, Chengdong-East industrial zone, yuyao city, zhejiang province

地址: 浙江省余姚城东工业区安山路 175 号

Tel/电话: 0574-62530115 Fax/传真: 0574-62531066 Web: www.weizhi-led.com

Optical & Electrical characteristics (光电特性曲线)

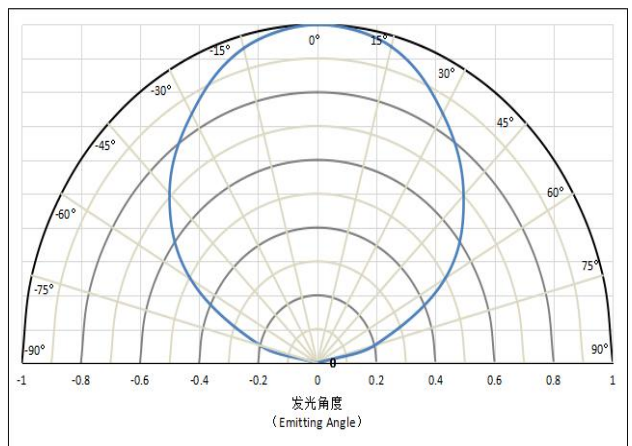
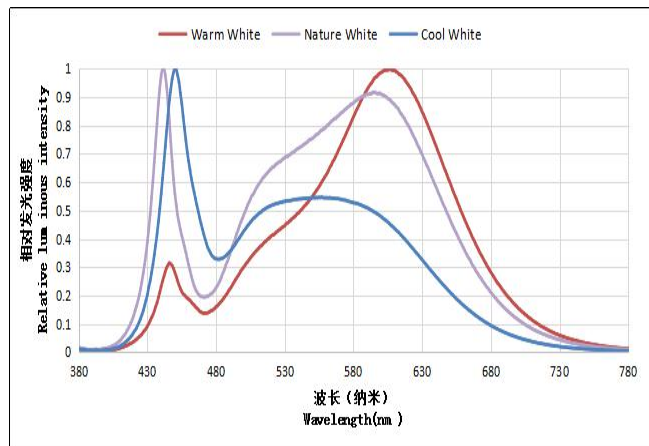
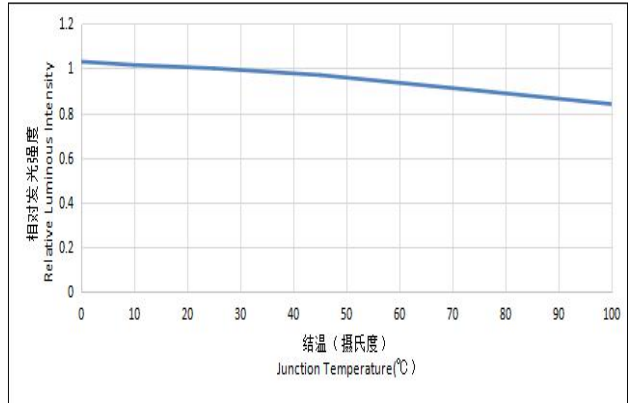
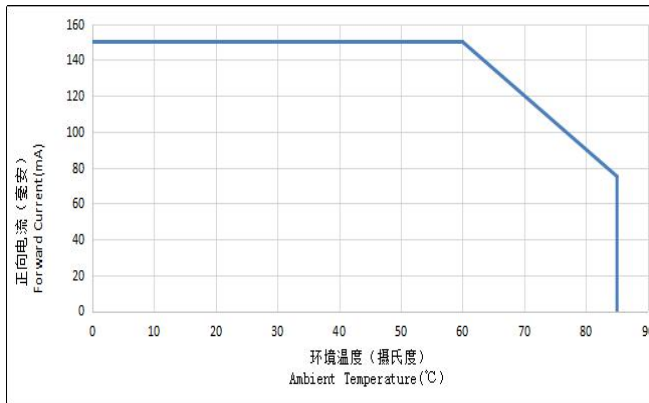
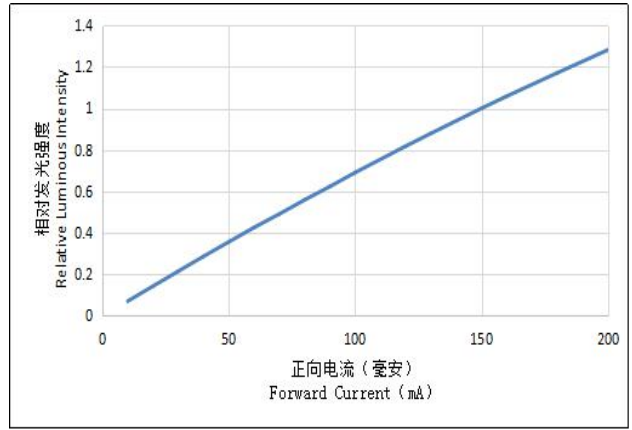
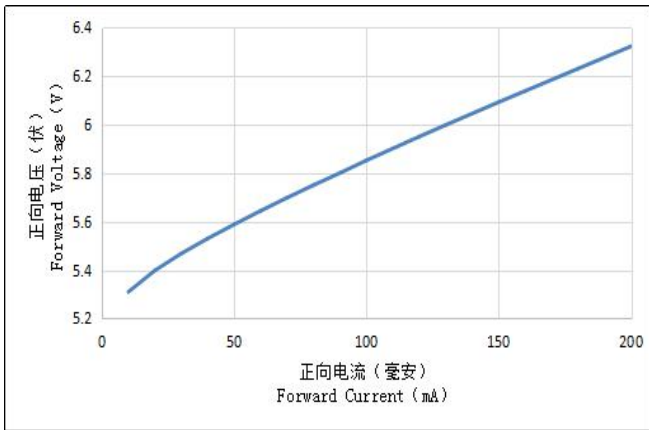

Adr: No.175,anshan road,Chengdong-East industrial zone,yuyao city,zhejiang province

地址: 浙江省余姚城东工业区安山路 175 号

Tel/电话: 0574-62530115 Fax/传真: 0574-62531066 Web:www.weizhi-led.com

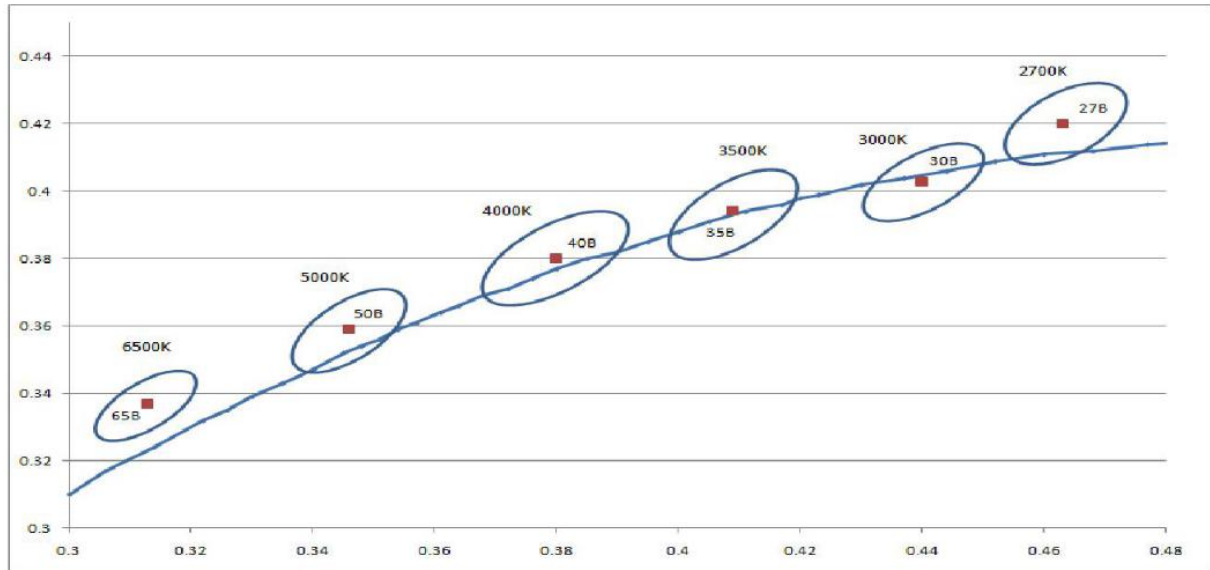
CIE Chromaticity Diagram(CIE 色度图)

Bin Range of Chromaticity Coordinate(Bin 范围与色坐标)

CCT	Bin code		CIE-X	CIE-Y
6500K	65B	6200-6800	0.313	0.337
5000K	50B	4800-5300	0.346	0.359
4000K	40B	3800-4200	0.380	0.380
3500K	35B	3250-3650	0.409	0.394
3000K	30B	2800-3200	0.44	0.403
2700K	27B	2600-2800	0.463	0.42

Adr: No.175,anshan road,Chengdong-East industrial zone,yuyao city,zhejiang province

地址: 浙江省余姚城东工业区安山路 175 号

Tel/电话: 0574-62530115 Fax/传真: 0574-62531066 Web:www.weizhi-led.com

Reliability Test (可靠性测试)

Type	Test Item (测试项目)	Test Conditions (测试条件)	Time (时间)	Number of Damaged (判定标准)
Environmental Sequence	Temperature Cycle (温度循环)	-45°C 30min ↑ ↓ 20 min 120°C 30min	100 cycle	0/22
	Thermal Shock (冷热冲击)	-10°C 15min ↑ ↓ 5sec 100°C 15min	100 cycle	0/22
	High Humidity Heat Cycle (湿热循环)	30°C — 65°C 90%RH 24hrs/1cycle	10 cycle	0/22
	High Temperature Storage (高温储存)	Ta=100°C	1000 hrs	0/22
	Humidity Heat Storage (高温高湿储存)	Ta=85°C RH=85%	1000 hrs	0/22
	Low Temperature Storage (低温储存)	Ta=-40°C	1000 hrs	0/22
Operation Sequence	Life Test (寿命测试)	Ta=25°C IF=20mA	1000 hrs	0/22
	High Humidity Heat Life Test (高温高湿寿命测试)	85°C RH=85% IF=15mA	500 hrs	0/22
	Low Temperature Life Test (低温寿命测试)	Ta=-20°C IF=30mA	1000 hrs	0/22

1. No LED Fail (没有死灯)
2. Lumen maintenance > 85% (流明维持率大于85%)
3. Change in Vf < 10% (电压变化小于10%)
4. Change in Wavelength $\Delta \lambda d \pm 1nm$ (色坐标漂移小于± 1nm)

Adr: No.175,anshan road,Chengdong-East industrial zone,yuyao city,zhejiang province

地址: 浙江省余姚城东工业区安山路 175 号

Tel/电话: 0574-62530115 Fax/传真: 0574-62531066 Web:www.weizhi-led.com

Label(标签):

CCT:Color Temperature 色温
 Φ (LM):Luminous flux 光通量
 VF:Forward Voltage 电压
 Ra:Color Rendering index 显色指数

 纬智光电科技有限公司			
P/N	*****		
Lot NO.	*****		
CCT	***	Ra	***
Φ	***	R9	***
VF	***	BIN	***
QTY	***	DATE	***

Packing (包装)

➤ Feeding Direction (供料方向)

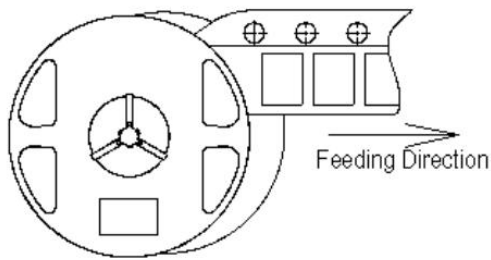

➤ Dimensions of Reel (卷盘尺寸) (Unit: mm)

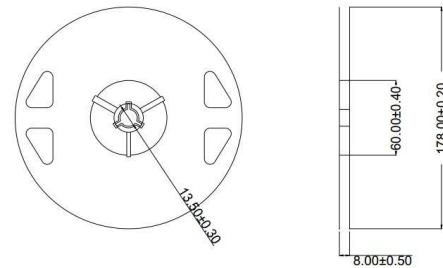

➤ Dimensions of Tape (载带尺寸) (Unit: mm)

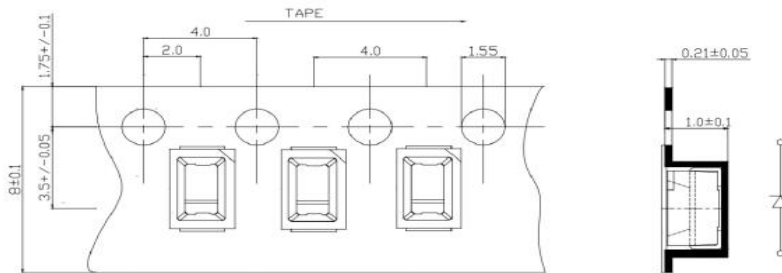

➤ Packaging specifications 包装规格

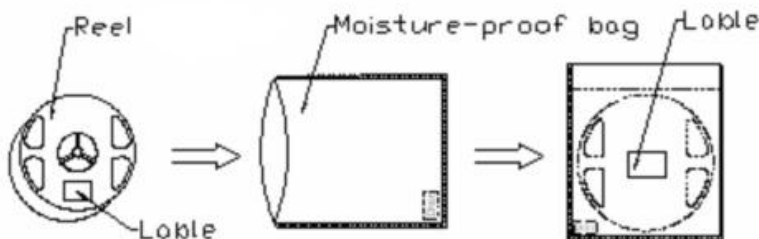

Note

1. 4,000pcs/Reel (4000pcs/每卷)
2. The maximum number of missing leds is two; (每卷最大误差为 2pcs)

Precaution For Use(使用注意事项)

➤ Reflow Soldering (回流焊)

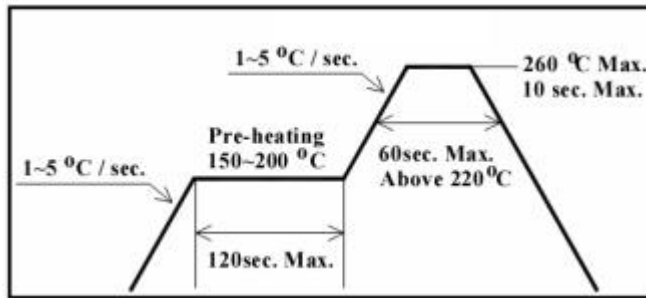

1. LED is moisture sensitive device. Solder paste also contains a large number of moisture. So we need notice before reflow soldering. LED in air exposure time do not exceed 4hrs.
(LED 是湿度敏感器件, 锡膏中也含有大量水分, 贴片完成后在空气中暴露时间不能超过 4 小时)
2. Reflow soldering should not be done more than one time. (只能回流焊一次)
3. Please choose the right nozzle to avoid the damage to products due to the pressure. (请选择合适的尺寸吸嘴避免对 LED 损伤)
4. After soldering, do not warp the PCB. (焊接后不要弯曲 PCB 板)

➤ Hand Soldering Conditions (手动焊接)

We recommend use reflow soldering. If you have to use manual soldering, please make sure that the iron must be properly grounded, do not exceed 3 seconds at maximum 310 ± 5 °C. (推荐回流焊, 如果必须手动焊接, 请确认电烙铁接地, 温度最高不超多 310°C, 时间最长 3 秒)

➤ Storage (储存)

Moisture-proof and anti-electrostatic package with moisture absorbent material is used, to keep moisture to a minimum. Before opening the package, the product should be kept at 30 °C or less and humidity less than 60% RH, and be used within a year. (本产品使用密封防潮抗静电袋包装, 并附有干燥剂, 开封前, 产品须存放在温度不高于 30°C, 湿度不高于 60%RH 的环境中。未开封的产品有一年的保存时间。)

It is recommended to baking before soldering when moisture-proof packing is unsealed exceed 24hrs. The Conditions are as followings: (开封后如果超出 24 小时请按以下要求除湿)

- 65 ± 3 °C / (>24hrs) and < 5%RH, taped reel type (连卷盘一起)
- 120 ± 3 °C / (2hrs~4hrs), bulk type (散装)
- 150 ± 3 °C / (1hr~2hrs), bulk type (散装)